



# BG30 SERIES

Today's digital intelligence  
moves your gate

Primo Florian: Founding partner - Engineering and design,  
Dino Florian: Founding President - Development and design,  
Renato Florian: Founding partner - Assembly and quality

## PEOPLE AND IDEAS

From the very beginning roger technology has evolved and grown because it's people believe that any bright idea can lead to great change in the future. Our people are passionate and innovative in our approach to every challenge, always pushing the boundaries to develop extraordinary products.

## PRODUCT EXPERIENCE

In our language we translate the word "experience" as passion. It is this passion that drives us in the development of revolutionary new products that serve the real needs of our customers. We understand that our customers want a product designed around the way that they work.



## Excellent raw materials

Steel, ductile cast iron, aluminium, bronze, copper and titanium have always been the main and exclusive raw materials used in the advanced engineering processes of our company.



## Production technology

At Roger Technology all internal manufacturing is carried out on optimised production lines making use of very advanced technology. We have invested heavily in robotics and automated all product manufacturing phases. This ensures that all components and semi-finished products are highly reliable, and are fully compliant with our exceptionally high quality standards.



## Internal assembly

Our highly qualified and dedicated staff oversee the fitting and assembly stages. Every piece of equipment is checked by our all Italian personnel to ensure that we deliver reliable products to our customers.



# Motor production

WE ARE THE CREATORS AT THE HEART OF THE PRODUCT!

All of our digital brushless motors are designed and manufactured in our own factories. Using dedicated automated machines the motors are wound with ultimate precision.



A digital brushless motor with permanent magnetic field, digital electronics for the complete management of the automation system control. Designed for super intensive use with the added benefit of a super low power consumption.

# THIS IS ROGER BRUSHLESS

## Digital Brushless Motor

Revolutionary and innovative digital Brushless motor with permanent magnetic field, three-phase sinusoidal power supply with native encoder that allows super-intensive use of the automation system with extremely low power consumption, not only providing 100% compliance with all the automation system management and safety rules, but setting new standards in gate safety.

## New Generation of Electronics

The new control unit with onboard digital Brushless controller. Without traditional relays and due to the revolutionary MOSFET quadrant system and its control technology entirely based on a DSP (Digital Signal Processor) microcontroller, it represents a new generation of electronic cards created to safely handle all movement phases of the automation system.

## Engineering Passion

All the mechanical components and gears are manufactured in steel, cast iron and bronze. The automation system casings are made from titanium-reinforced die-cast aluminium. All the gears are inspected and assembled on high-quality bearings and inserted on precise seats machined to provide absolute precision between the axes.



### 3-PHASE DIGITAL BRUSHLESS MOTOR

A very powerful motor with substantial torque. The motor is compact and neat due to the special concentrated coil windings, it is powered by a three phase sinusoidal system.



### DIGITAL AND VECTORIAL AUTOMATION CONTROLLER

The BRUSHLESS digital controller, which operates at low voltage 24V/36V DC, allows 100% control of the automation system in digital mode. Due to its operation entirely based on a DSP microcontroller the travel and all the movements of your automation system can therefore be programmed and customised easily, precisely and elegantly.



### SPEED, ACCELERATION AND DECELERATION WITH EXTREME ELEGANCE

The automation system with brushless digital technology creates perfect and elegant movements. With a constant force and torque at every point and with the option of varying the speed on deceleration and acceleration the system can be managed with maximum safety.



### EXTREMELY LOW ENERGY CONSUMPTION

A motor that can operate at low voltage in super-intensive use and which can operate in environments with extremely demanding weather conditions while maintaining very low energy consumption and absorption levels. We can move a 600 kg sliding gate and use less than 30W of power.



### NO PROBLEM IN THE EVENT OF POWER FAILURE

With the help of internal or external batteries and the associated battery charging card, your automation system continues to operate for a considerable time even during prolonged power cuts, ensuring many more operations than traditional technologies.

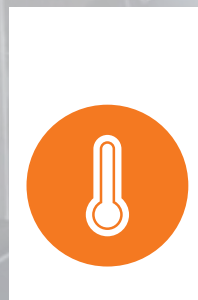

### MOTOR AT AMBIENT TEMPERATURE

The BRUSHLESS motor was created with the main goal of being a motor for super intensive use and with a 99% efficiency. Regardless of how many operations the engine performs in a day, it always remains cold or at the most reaches the outside ambient temperature.

# COMPLETELY BRUSHLESS

## The revolutionary digital motor with 12 unique features



### THE DIGITAL SILENCE OF THE MOTOR

One great impact is the silence or the near absence of noise, generated by the BRUSHLESS motor during all its movements.



### MOTOR FOR SUPER-INTENSIVE USE

We wanted to surprise our customers with a product that was fundamentally different to any other product on the market. Fact: our motor remains permanently cold even after many days of super intensive use.



### IMPACT, OBSTACLE DETECTION AND REVERSAL IN TOTAL SAFETY

Thanks to digital technology we are able to detect an obstacle and reverse the motor instantly, by simply specifying the torque of the motor, the sensitivity, the time and the travel of the reversal. All in full compliance with safety requirements.

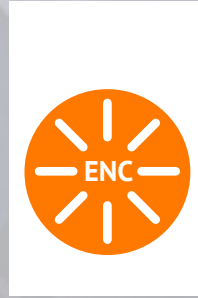

### ONBOARD NATIVE DIGITAL ENCODER

The BRUSHLESS motor has a highly advanced native digital encoder that controls management of automation systems in a safe, precise and extremely elegant manner.



### SIMPLE INSTALLATION WITH A SINGLE 3-WIRE CABLE

The BRUSHLESS motor can be installed by simply connecting it using three wires! What could be easier? This will provide full digital management of your automation system thanks to the sensoreless and sensed (absolute encoder) technology incorporated in the BRUSHLESS sliding gate motors.



### ADVANCED PRECISION ENGINEERING TO OBTAIN OPTIMAL MOTOR PERFORMANCE

We have created a mechanism that gives you the opportunity to get the maximum performance out of the motor. A product which combines the quality of the internal production processes, the mechanical processing and the use of high quality ferrous and non-ferrous materials.

# A technology that offers maximum performance but consumes less power than other motors

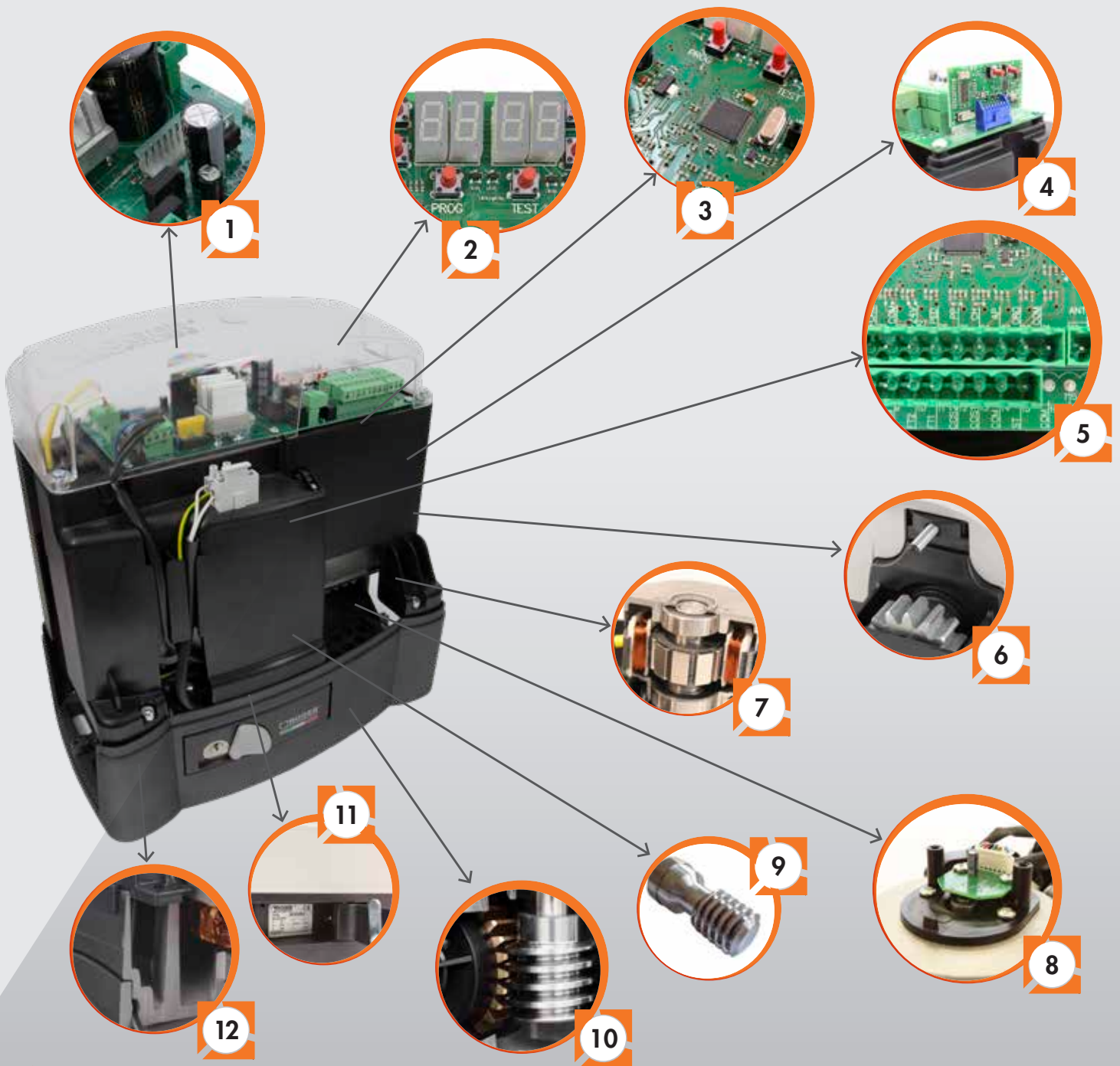

# WHY BRUSHLESS...?

Digital, smart, powerful,  
elegant, robust  
and all-Italian.





## Standby batteries in the event of power failure

No problem in case of blackout, thanks to the onboard charging card housed in a protected position inside the gate operator cover. In Plug-In Mode the onboard charging card allows to manage two external 12V DC/4,5 Amp/H standby batteries.



## BRUSHLESS digital motor

Digital brushless motor based on a permanent magnetic field which uses neodymium iron-boron magnets inside the rotor. With special concentrated coil windings, powered by a three-phase sinusoidal power system and available in 24V, 36V and 220V AC versions, the motor is extremely compact and operates at ambient temperature, guaranteeing super-intensive use with extremely low consumption.



## Multifunction digital display

4-quadrant digital display with 6 function keys that allow you to go through the various parameters, change their values, check error messages and input statuses and perform all the self-learning phases.



## Extremely powerful digital encoder

Thanks to the SENSORED technology and the native encoder in the motor, it is possible to exploit the technology provided by a motor encoder with a computing capacity of 4096 pulses per revolution. An effective power control that allows safe management of the automation system in all its movements, especially in the obstacle detection phases.



## Micro-controller with DSP technology

The digital controller controls the brushless motor via a single 3 core cable, managing your automation system entirely digitally with SENSORED motor power control technology



## High quality worm gears and bearings

Special worm gears and motor shafts obtained by pressure rolling processes guarantee durability and silence. Use of high-quality ball bearings with double protection.



## Plug-in 2-channel radio receiver

Powerful 2-channel radio receiver with up to 500 storable radio controls, available in fixed code or rolling code versions.



## High precision engineering

Reducer gears made with only with high quality materials such as aluminium, steel, cast iron and bronze; gears assembled with high-quality double-shielded ball bearings in order to obtain absolute precision between their axes.



## Wide availability of inputs

The digital controller offers a wide range of inputs for management and connection of all accessories and safety devices.



## Eccentric aluminium lock release lever

The release lever is made entirely of aluminium with opening by key cylinder. The opening system is based on a very robust and powerful eccentric operating method, and on the principle of the double lever, which unlocks the automation system easily and reliably.



## Limit switch for any installation

The whole range of sliding gate motors in the BG30 series is available with a mechanical limit switch or magnetic limit switch managed by the powerful onboard native digital encoder.



## Reinforced aluminium body

The BG30 body is made completely of aluminium reinforced with titanium. The thicknesses are increased and reinforced in the areas of greatest stress or possible wear. Treatment with epoxy paints to protect the body from the weather.

# Dimensions

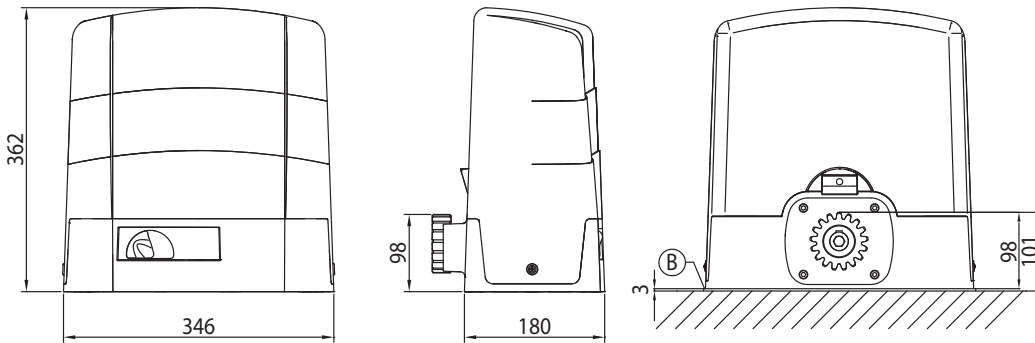

## Preparations for standard installation

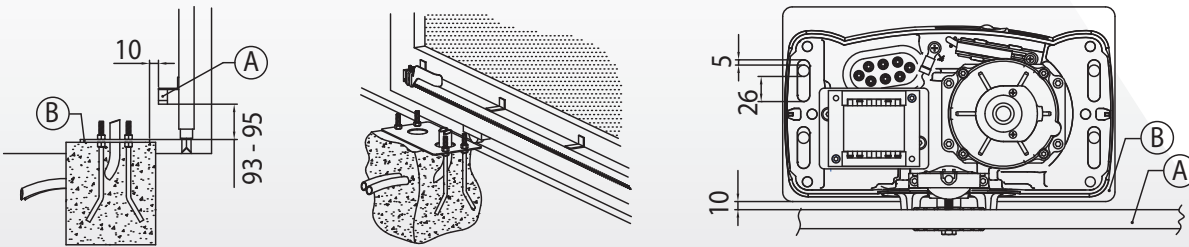





A = Rack

B = Fastening plate (thickness 3mm)

Note: All measurements in the drawings are in millimetres





# Technical SPECIFICATIONS

	BG30/1604	BG30/2204	BG30/1004/HS	BG30/1504/HS	BG30/1404/R	BG30/1804/HS
Code Description	Electromechanical BRUSHLESS motor, low voltage, intensive use, ideal for sliding gates up to 1600 kg.	Electromechanical BRUSHLESS motor, low voltage, intensive use, ideal for sliding gates up to 2200 kg.	Electromechanical HIGH SPEED BRUSHLESS motor, low voltage, intensive use, ideal for sliding gates up to 1000 kg.	Electromechanical HIGH SPEED BRUSHLESS motor, low voltage, intensive use, ideal for sliding gates up to 1500 kg.	Electromechanical BRUSHLESS motor, low voltage, intensive use, ideal for sliding gates up to 1400 kg.	Electromechanical HIGH SPEED BRUSHLESS motor, low voltage, intensive use, ideal for sliding gates up to 1800 kg.
Reductor Type	Irreversible	Irreversible	Irreversible	Irreversible	Reversible 	Irreversible
Max gate weight	1600 kg	2200 kg	1000 kg	1500 kg	1400 kg	1800 kg
Line power supply	230V AC - 115V AC 50/60Hz +-10%	230V AC - 115V AC 50/60Hz +-10%	230V AC - 115V AC 50/60Hz +-10%	230V AC - 115V AC 50/60Hz +-10%	230V AC - 115V AC 50/60Hz +-10%	230V AC - 115V AC 50/60Hz +-10%
Brushless motor power supply	36V	36V	36V	36V	36V	36V
Max power	390W	470W	590W	650W	540W	650W
Frequency of use	Intensive	Intensive	Intensive	Intensive	Intensive	Intensive
Operating temperature	-20 +55°C	-20 +55°C	-20 +55°C	-20 +55°C	-20 +55°C	-20 +55°C
Degree of protection	IP43	IP43	IP43	IP43	IP43	IP43
Max Speed of operation	0,20 m/sec	0,16 m/sec	0,33 m/sec 	0,41 m/sec 	0,28 m/sec	0,30 m/sec 
Max Thrust	1200 N	1700 N	800 N	1000 N	600 N	1250 N
Encoder	Digital native encoder	Digital native encoder	Digital native encoder	Digital native encoder	Digital native encoder	Digital native encoder
Typology encoder	Digital SENSORED	Digital SENSORED	Digital SENSORED	Digital SENSORED	Digital SENSORED	Digital SENSORED
Limit switch type	Magnetic	Magnetic	Magnetic	Magnetic	Magnetic	Magnetic
Onboard control unit	B70/1DCHP	B70/1DCHP	B70/1DCHP	B70/1DCHP	B70/1DCHP	B70/1DCHP
Daily operation cycles (open / close - 24 hours non-stop)	1000	1000	800	800	800	800
Packaged product weight	19,6 kg	20,0 kg	19,6 kg	20 kg	20,0 kg	20,0 kg
Release	Eccentric lever with key cylinder	Eccentric lever with key cylinder	Eccentric lever with key cylinder	Eccentric lever with key cylinder	Eccentric lever with key cylinder	Eccentric lever with key cylinder
Rack module	4	4	4	4	4	4
Pinion Type	Z-17 module 4	Z-17 module 4	Z-17 module 4	Z-17 module 4	Z-17 module 4	Z-17 module 4
Number of packages per pallet	40	40	40	40	40	40



# FUNCTIONS of automated sliding gate motor

DESCRIPTION	BG30/1604	BG30/2204
Max gate weight	Up to 1600 kg	Up to 2200 kg
Onboard digital controller	B70/1DCHP	B70/1DCHP
Radio receiver type	H93/RX22A/1 with fixed code connection H93/RX2RC/1 with rolling code connection	H93/RX22A/1 with fixed code connection H93/RX2RC/1 with rolling code connection
Motor power supply	36V DC	36V DC
Motor management technology (ETC)	SENSORED technology	SENSORED technology
Encoder type	Magnetic Digital SENSORED, 4096 pulses per revolution	Magnetic Digital SENSORED, 4096 pulses per revolution
Mains power supply	230V 50/60 Hz	230V 50/60 Hz
Battery operation	(optional) 2 external batteries 12V DC, 4.5 a/h	(optional) 2 external batteries 12V DC, 4.5 a/h
Energy consumption	Very low consumption	Very low consumption
Number of motors	1	1
Power supply for accessories	24V DC	24V DC
Flashing light type	24V DC LED	24V DC LED
Output for gate opening indicator and automation system on warning light	√	√
Output for courtesy light	40W	40W
Timed and guaranteed automatic closing	√	√
Gate edge safety management, 8.2KΩ or standard	√	√
Limit switch type	Magnetic	Magnetic
Force adjustment in nominal movement	√	√
Force adjustment in start-up and deceleration	√	√
Obstacle detection (also in position recovery mode) - Motor reversal	√	√
Speed adjustment	√	√
Deceleration	√	√
Management of the slowdown starting point	√	√
Starting acceleration (soft-start)	√	√
Guaranteed closing	√	√
Stopping space and motor braking	√	√
Partial opening control	Pedestrian entry	Pedestrian entry
Human presence control	√	√
Condominium function	√	√
Safety device configuration	√	√
Installation test function	(prog button)	(prog button)
Operating temperature	-20°C/+55°C	-20°C/+55°C
Inverter thermal protection	√	√
Restore factory default values	√	√
Information on use of motor	√	√
Security password management	√	√

BG30/1004/HS 	BG30/1504/HS 	BG30/1404/R 	BG30/1804/HS 
up to 1000 kg	up to 1500 kg	up to 1400 kg	up to 1800 kg
B70/1DCHP	B70/1DCHP	B70/1DCHP	B70/1DCHP
H93/RX22A/1 with fixed code connection H93/RX2RC/1 with rolling code connection	H93/RX22A/1 with fixed code connection H93/RX2RC/1 with rolling code connection	H93/RX22A/1 with fixed code connection H93/RX2RC/1 with rolling code connection	H93/RX22A/1 with fixed code connection H93/RX2RC/1 with rolling code connection
36V DC	36V DC	36V DC	36V DC
SENSORED technology	SENSORED technology	SENSORED technology	SENSORED technology
Magnetic Digital SENSORED, 4096 pulses per revolution	Magnetic Digital SENSORED, 4096 pulses per revolution	Magnetic Digital SENSORED, 4096 pulses per revolution	Magnetic Digital SENSORED, 4096 pulses per revolution
230V 50/60 Hz	230V 50/60 Hz	230V 50/60 Hz	230V 50/60 Hz
(optional) 2 external batteries 12V DC, 4.5 a/h	(optional) 2 external batteries 12V DC, 4.5 a/h	(optional) 2 external batteries 12V DC, 4.5 a/h	(optional) 2 external batteries 12V DC, 4.5 a/h
Very low consumption	Very low consumption	Very low consumption	Very low consumption
1	1	1	1
24V DC	24V DC	24V DC	24V DC
24V DC LED	24V DC LED	24V DC LED	24V DC LED
√	√	√	√
40W	40W	40W	40W
√	√	√	√
√	√	√	√
Magnetic	Magnetic	Magnetic	Magnetic
√	√	√	√
√	√	√	√
√	√	√	√
Adjustable separately in opening and closure	Adjustable separately in opening and closure	Adjustable separately in opening and closure	Adjustable separately in opening and closure
Adjustable separately in opening and closure	Adjustable separately in opening and closure	Adjustable separately in opening and closure	Adjustable separately in opening and closure
√	√	√	√
Adjustable separately in opening and closure	Adjustable separately in opening and closure	Adjustable separately in opening and closure	Adjustable separately in opening and closure
√	√	√	√
√	√	√	√
Pedestrian entry	Pedestrian entry	Pedestrian entry	Pedestrian entry
√	√	√	√
√	√	√	√
√	√	√	√
(prog button)	(prog button)	(prog button)	(prog button)
-20°C/+55°C	-20°C/+55°C	-20°C/+55°C	-20°C/+55°C
√	√	√	√
√	√	√	√
√	√	√	√
√	√	√	√

# ACCESSORIES

BG30 everything you need for a complete, professional installation.

## OPTIONAL ACCESSORIES



KT222

Raised fastening plate for G30 series



LT331

Pinion Z11 mod. 6



GA550

Steel rack 22x22x1000, galvanised, module 4



B71/BCHP/EXT

Kit for emergency batteries charger with plug-in card, with 2 recovery batteries 12V DC, 4.5 Ah. Box case included



GA551

Steel rack 30x12x1000, galvanised, module 4, complete with spacers and screws



B71/BCHP/BOX

Kit for emergency batteries charger. Box case included and without recovery batteries



GA553

Nylon rack, module 4, 6 attachments, length 1000



GA554

Pack of 6 spacers with screws



LT328

Z17 mod. 4 Pinion with increased thickness H.38



R99/C/001

"Automatic Opening" warning notice

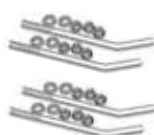

BG30/1603 - BG30/2203  
BG30/1003/HS



BG30/1604 - BG30/2204  
BG30/1004/HS  
BG30/1404/R

## STANDARD ACCESSORIES

Always included in the individual product package or kit

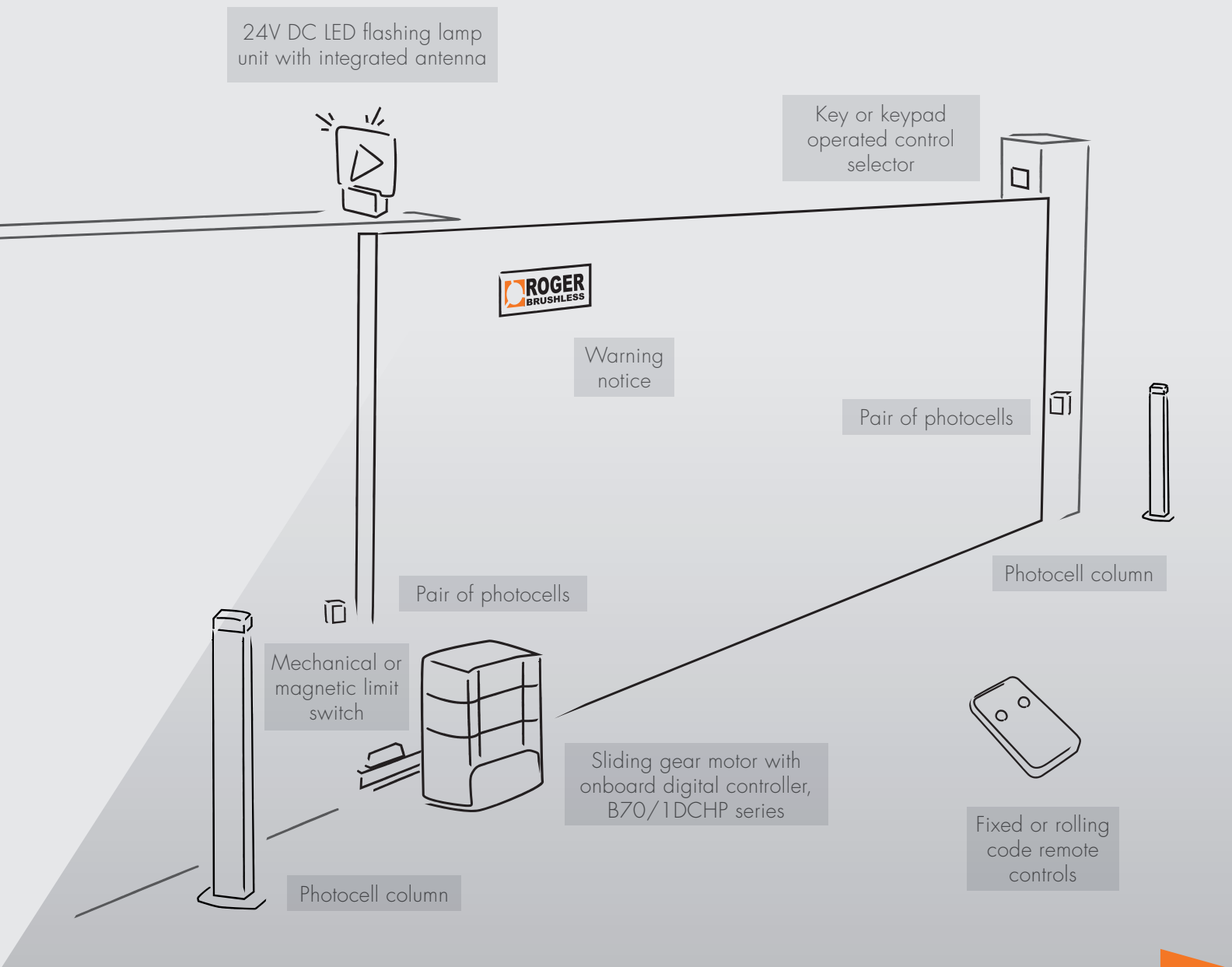

# STANDARD INSTALLATION

A practical example  
for your successful



WWW.WEAREBRUSHLESS.COM



PREMIUM DEALER / AUTHORISED DEALER



# ROGER TECHNOLOGY

Via S. Botticelli, 8 - 31021, Bonisiolo di Mogliano Veneto (TV) - ITALY  
T. +39 041 5937023 - F. +39 041 5937024

WWW.ROGERTECHNOLOGY.COM

