

LOCINOX

MOTORS FOR GATES



www.locinox.com



HQ: +32 56 77 27 66
CEE: +48 71 758 21 00



help@locinox.com



www.locinox.com/
electradrop-e



www.kapumotorbolt.hu



+3623880868



ertekistes@m4g.hu



www.locinoxusa.com/
electradrop-e

ELECTRADROP-E

5 m (4x 0,5 mm²)
16' 4" (4x 24 ga)

ELECTRADROP-E-P

5 m (7x 0,5 mm²)
16' 4" (7x 24 ga)

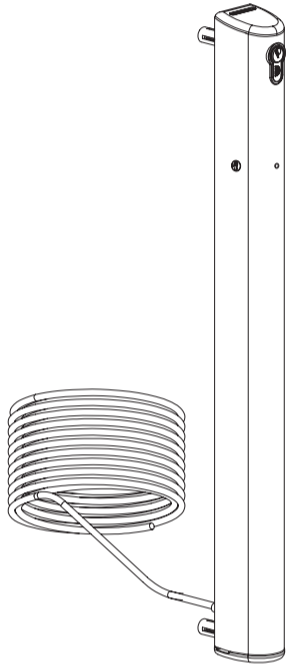

QUICK-FIX

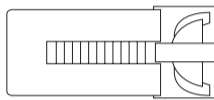

NYITVA

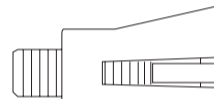

ZÁRVA

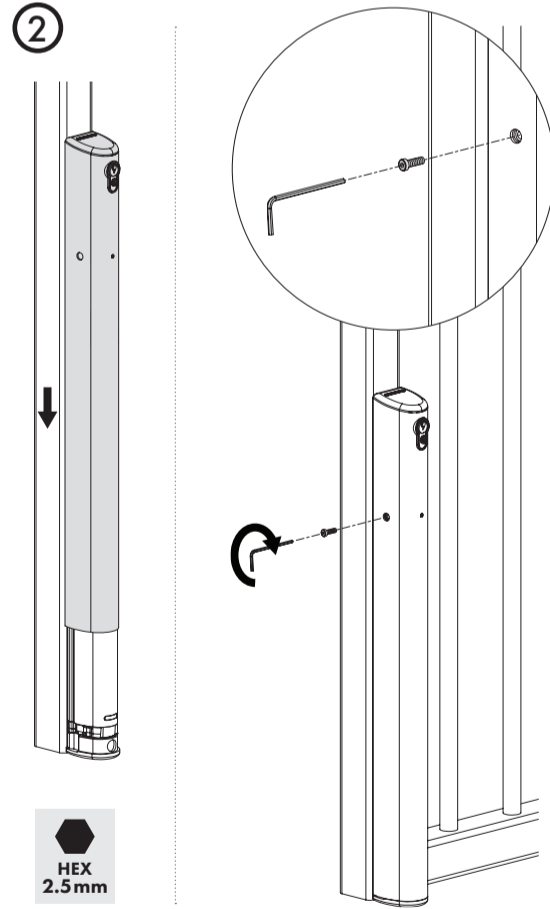
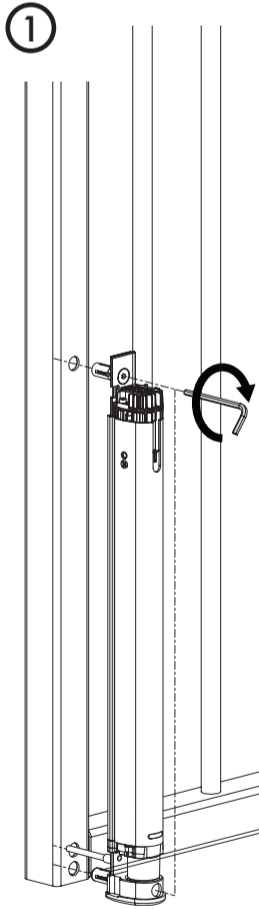
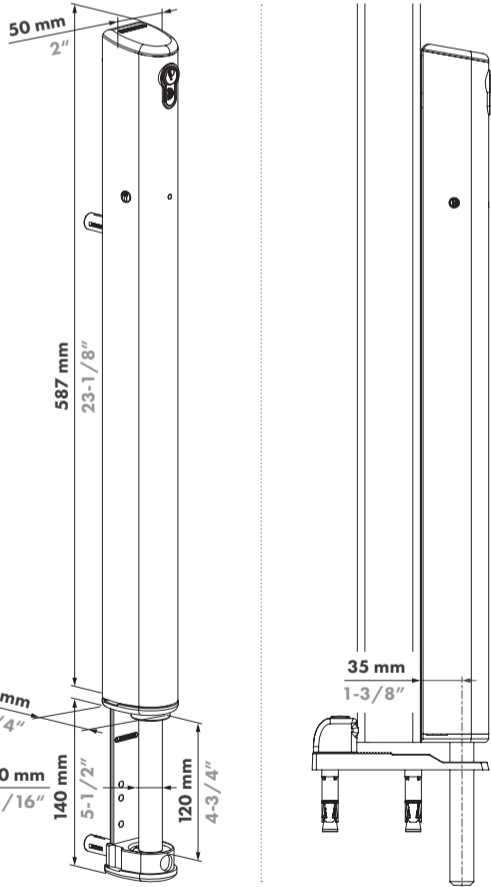
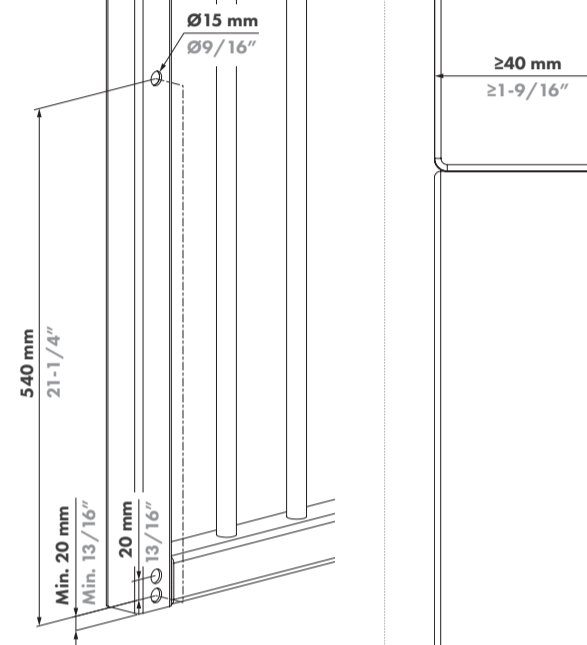

BIZTONSÁGI NYITÁS

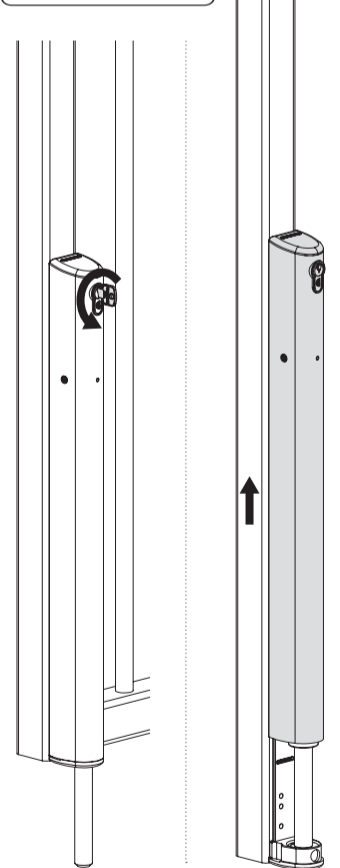

pictures@locinox.com

SUCCESSFUL INSTALLATION?
Please send us your pictures & videos

SUCCEVOLLE INSTALLATIE?
Stuur gerust uw foto's & video's door

INSTALLATION RÉUSSIE?
Veuillez nous envoyer vos photos & vidéos

ERFOLGREICHE INSTALLATION?
Bitte senden Sie uns Ihre Bilder & Videos

INSTALACION EXITOSA?
Por favor envíenos sus fotos y videos

UDANA INSTALACJA?
Prześlij nam swoje zdjęcia i filmy

SIKERES TELEPÍTÉS?
Kérjük küldje el elkészült videóit és fényképeit

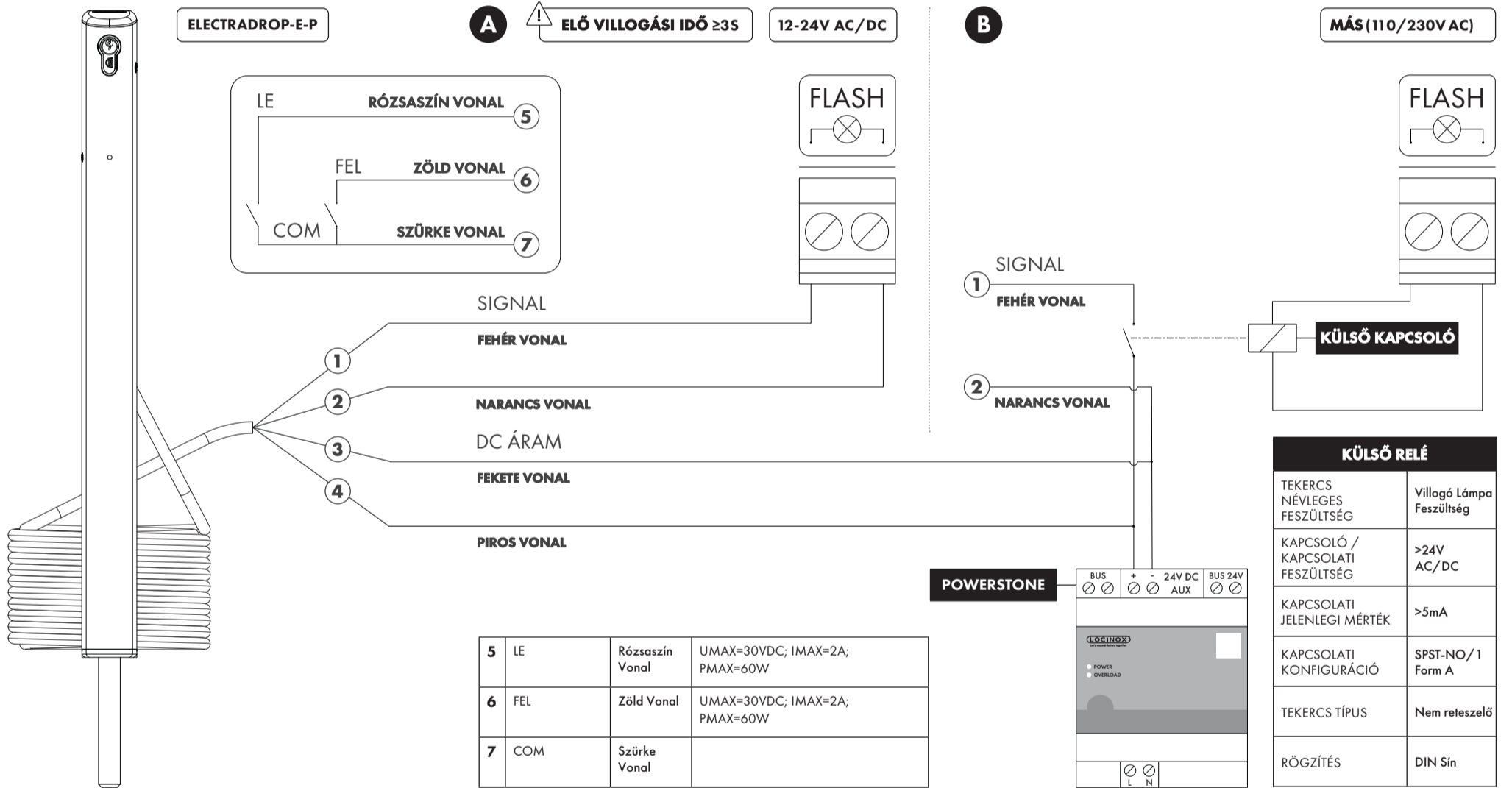
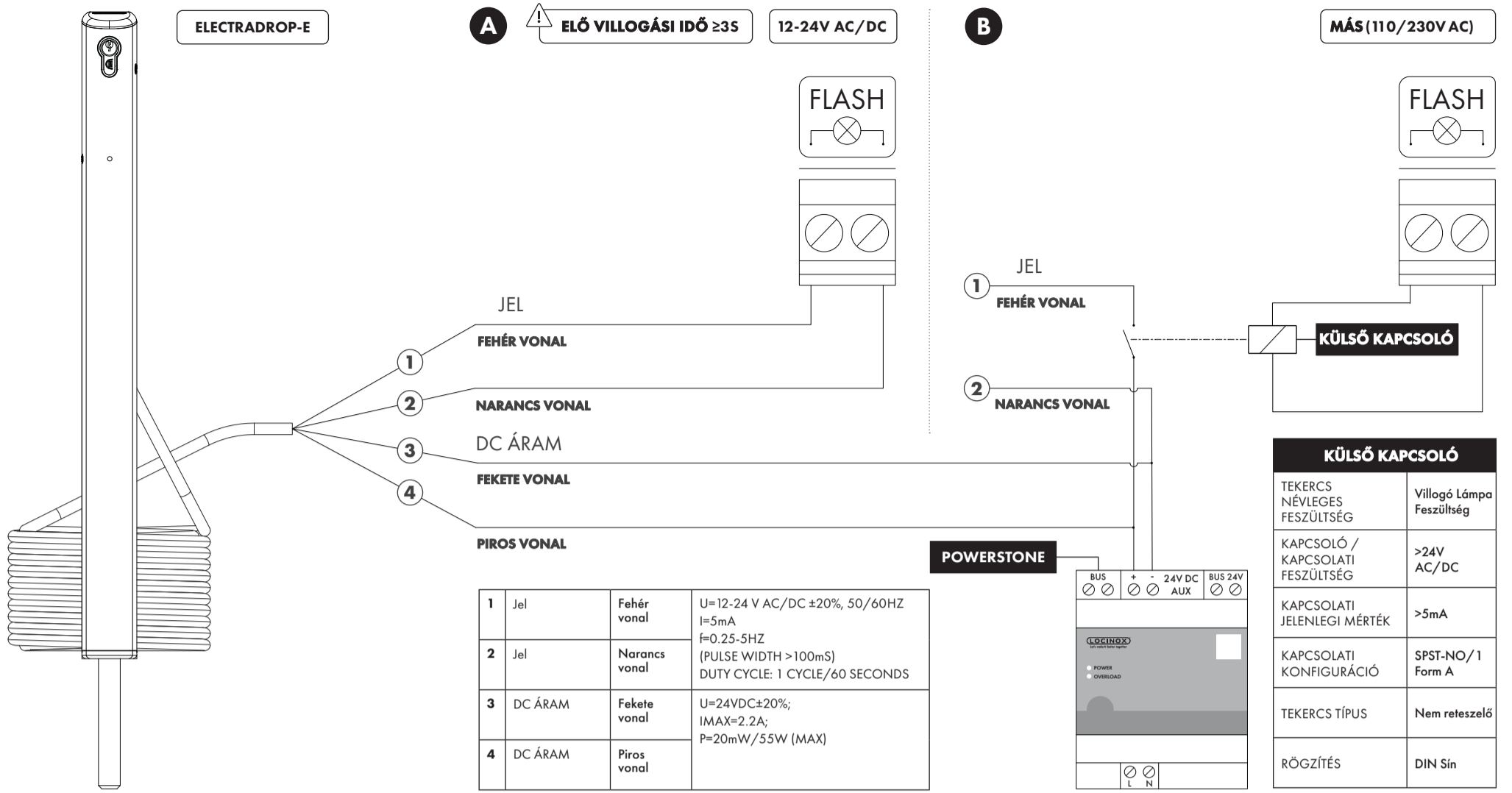

KIMENETI POZÍCIÓ

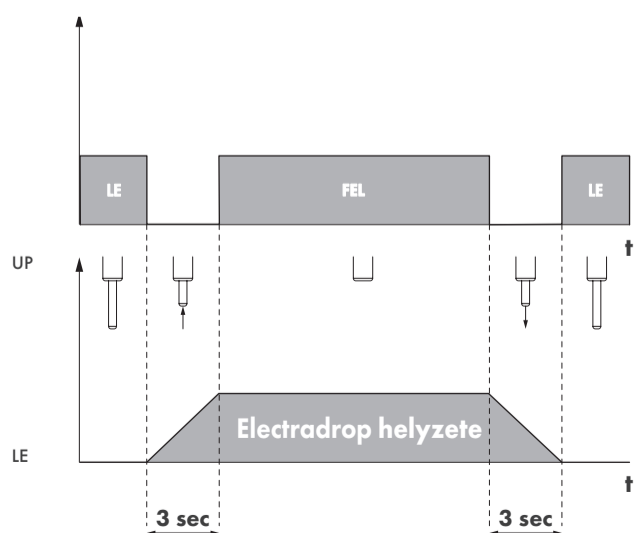

ELECTRADROP-E FOLYAMATOS JELZÉS

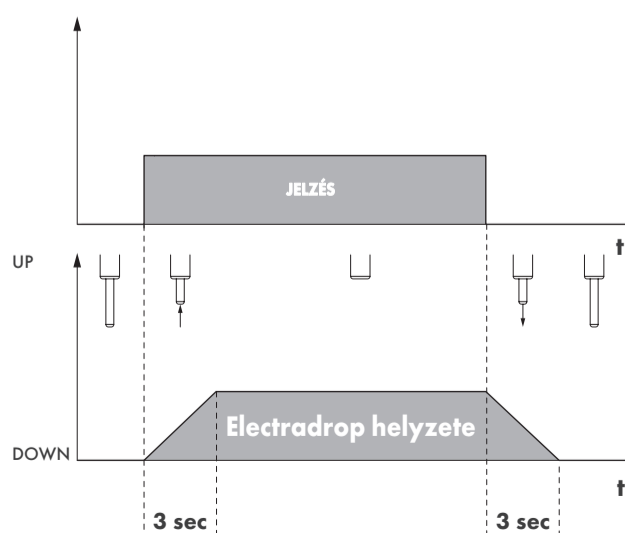

ELECTRADROP-E PULZÁLÓ JELZÉS

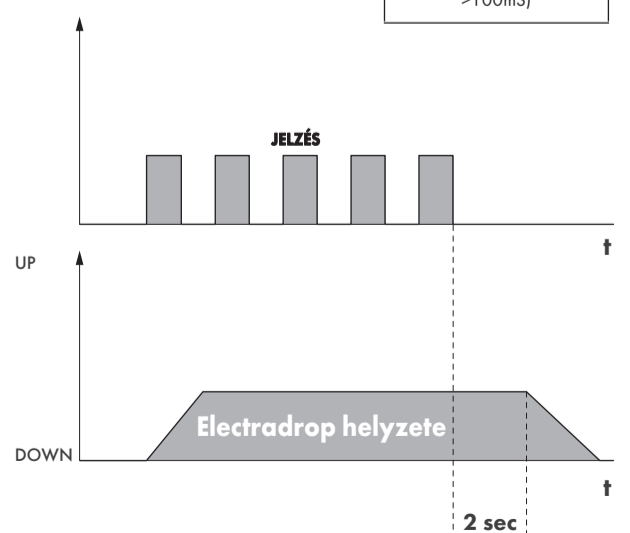

ELECTRADROP-R ELECTRADROP-R-P



ELECTRADROP-R

5 m (4x 0,5 mm²)
16' 4" (4x 24 ga)

ELECTRADROP-R-P

5 m (7x 0,5 mm²)
16' 4" (7x 24 ga)

CE FC

QUICK-FIX

NYITVA

ZÁRVA

LOCINOX	MOTORS FOR GATES
LIVE CHAT	AI CHAT
www.locinox.com	www.kapumotorbolt.hu
HQ: +32 56 77 27 66 CEE: +48 71 758 21 00	+3623880868
help@locinox.com	ertesites@m4g.hu
www.locinox.com/electradrop-r	www.locinoxusa.com/electradrop-r

50 mm
2"

587 mm
23-1/8"

58 mm
2-1/4"

Ø20 mm
Ø13/16"

120 mm
4-3/4"

140 mm
5-1/2"

35 mm
1-3/8"

≥40 mm
≥1-9/16"

Ø15 mm
Ø9/16"

540 mm
21-1/4"

20 mm
13/16"

Min. 20 mm
Min. 13/16"

Ø9/16"
Ø15mm

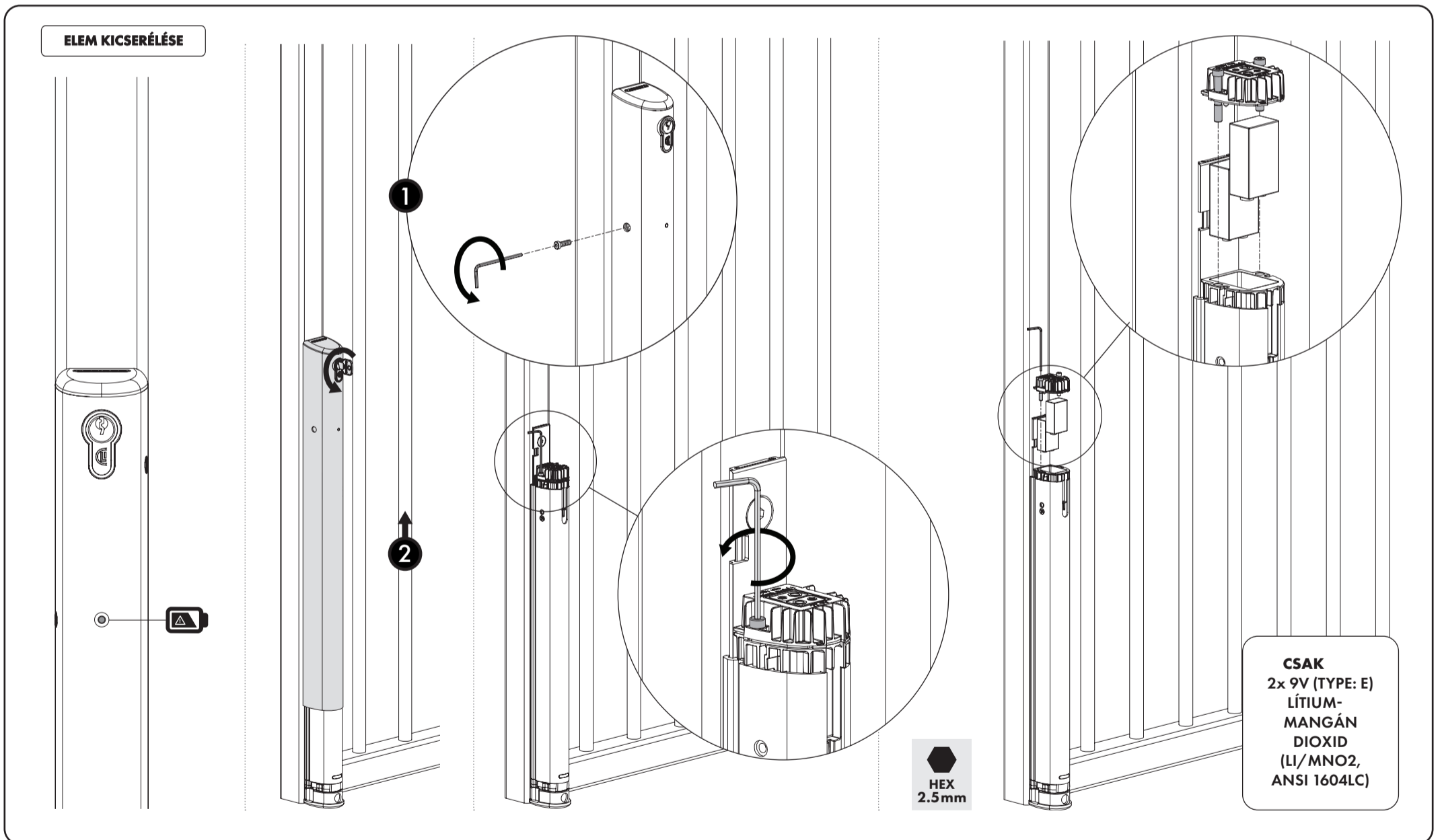
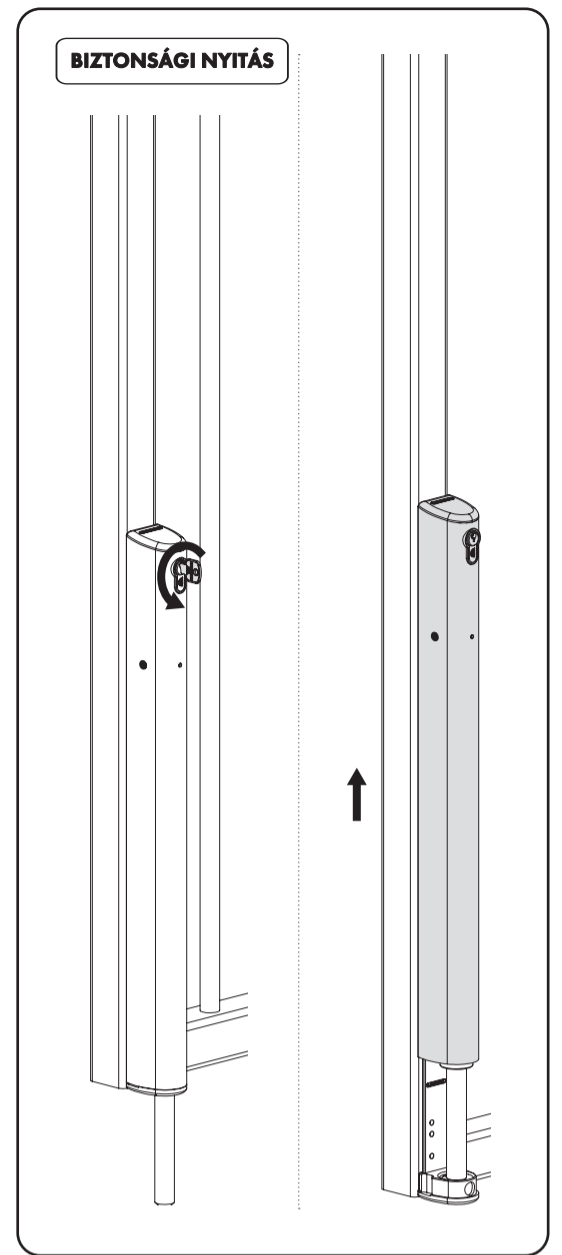
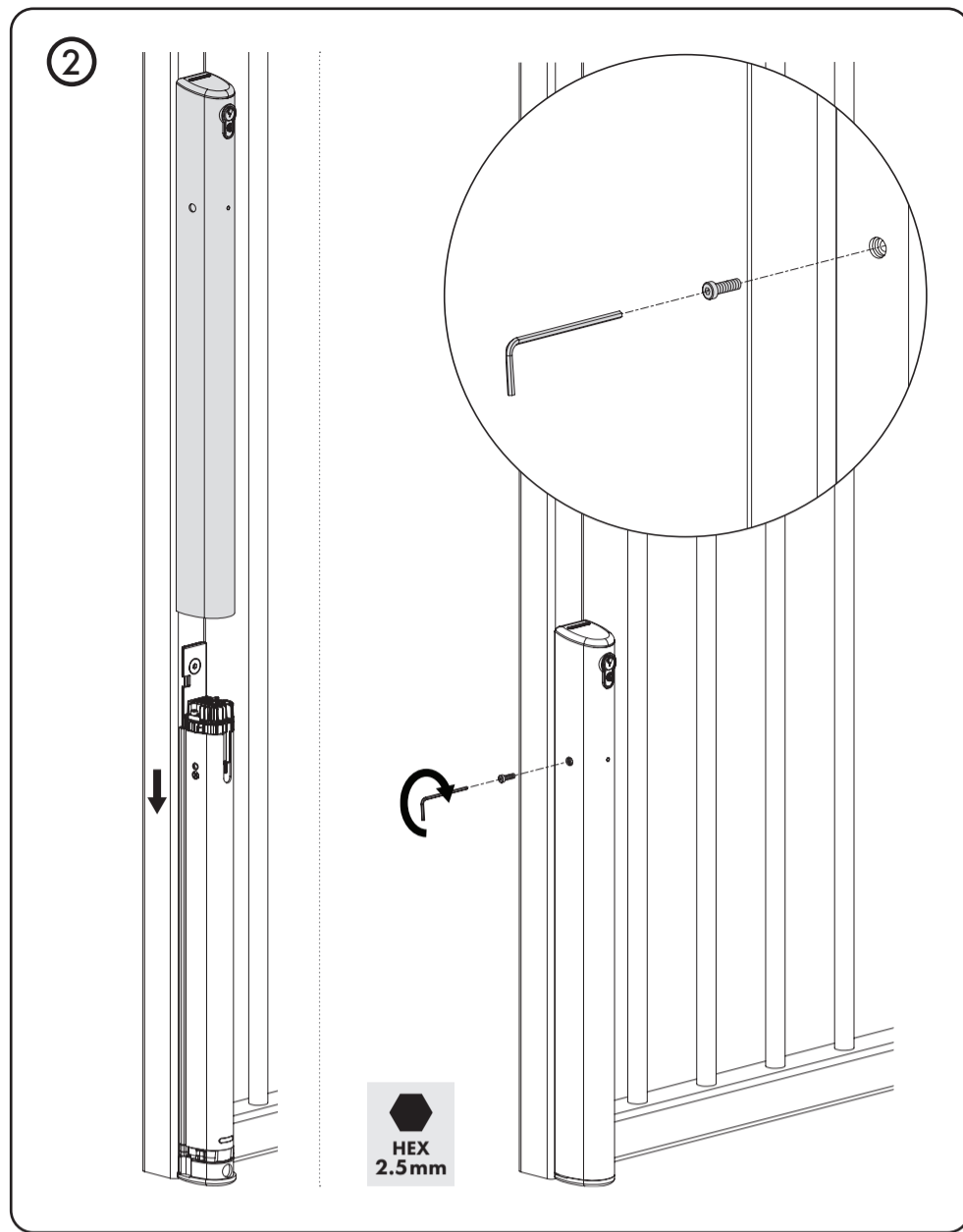
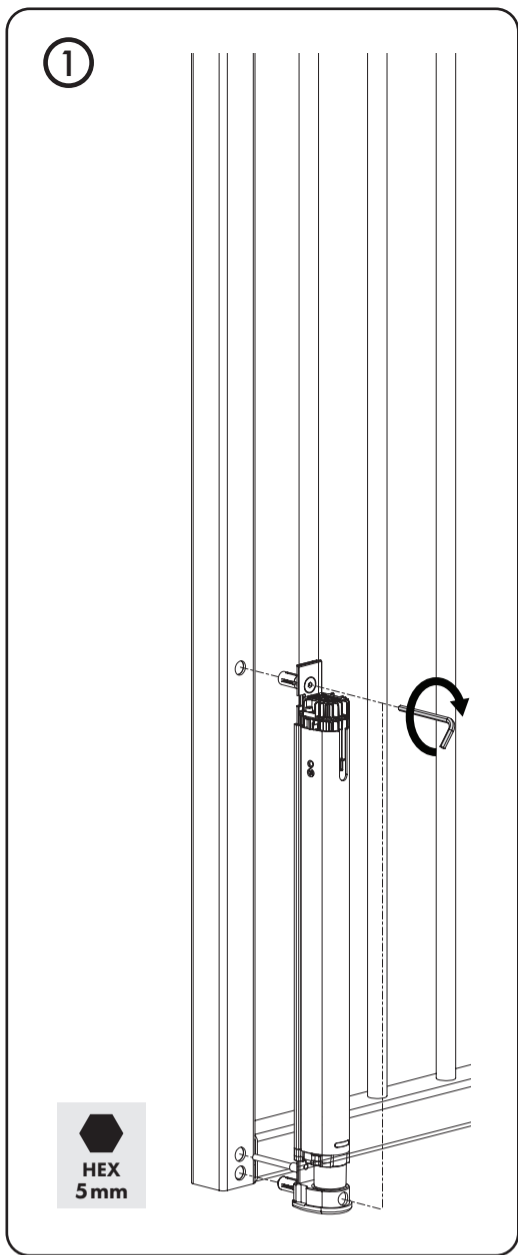

<p>pictures@locinox.com</p>	<p>SUCCESSFUL INSTALLATION?</p> <p>Please send us your pictures & videos</p>	<p>SUCCESVOLLE INSTALLATIE?</p> <p>Stuur gerust uw foto's & video's door</p>	<p>INSTALLATION RÉUSSIE?</p> <p>Veuillez nous envoyer vos photos & vidéos</p>	<p>ERFOLGREICHE INSTALLATION?</p> <p>Bitte senden Sie uns Ihre Bilder & Videos</p>	<p>INSTALACION EXITOSA?</p> <p>Por favor envíenos sus fotos y videos</p>	<p>UDANA INSTALACJA?</p> <p>Prześlij nam swoje zdjęcia i filmy</p>	<p>SIKERES TELEPÍTÉS?</p> <p>Kérjük küldje el elkészített videóit és fényképeit</p>
---	--	--	---	--	--	--	---

LOCINOX®
Let's make it better together

MOTORS GATES

Doc. Nr.: **MANU-000464**

Locinox NV • Brabantstraat 107 • 8790 Waregem • Belgium
 Locinox CEE • Irysowa 9 • 55-040 Bielany Wrocławskie • Poland
 Locinox LLC • 460 Windy Point Drive • Glendale Heights - IL 60139 • USA

MANU-000464

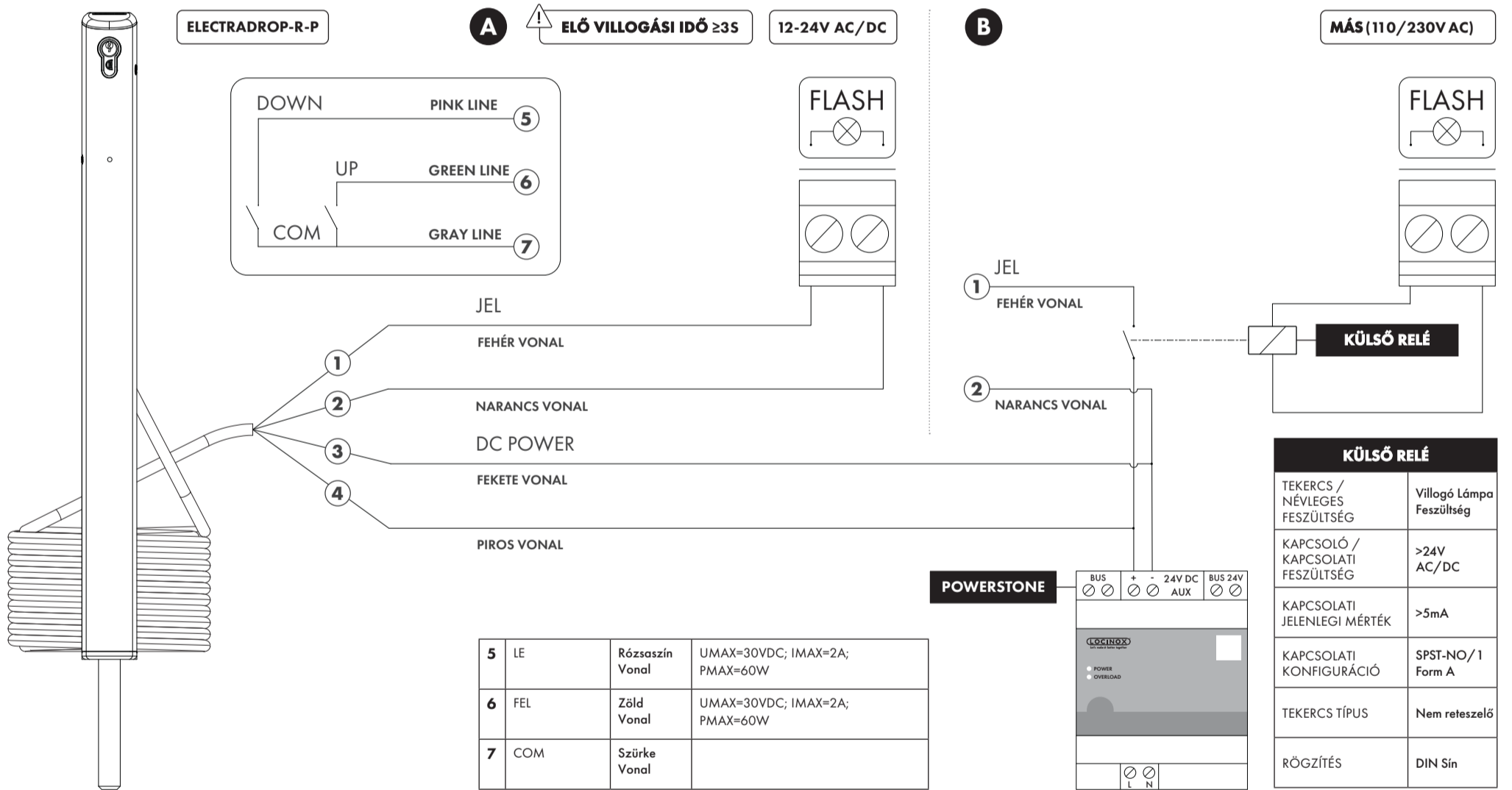
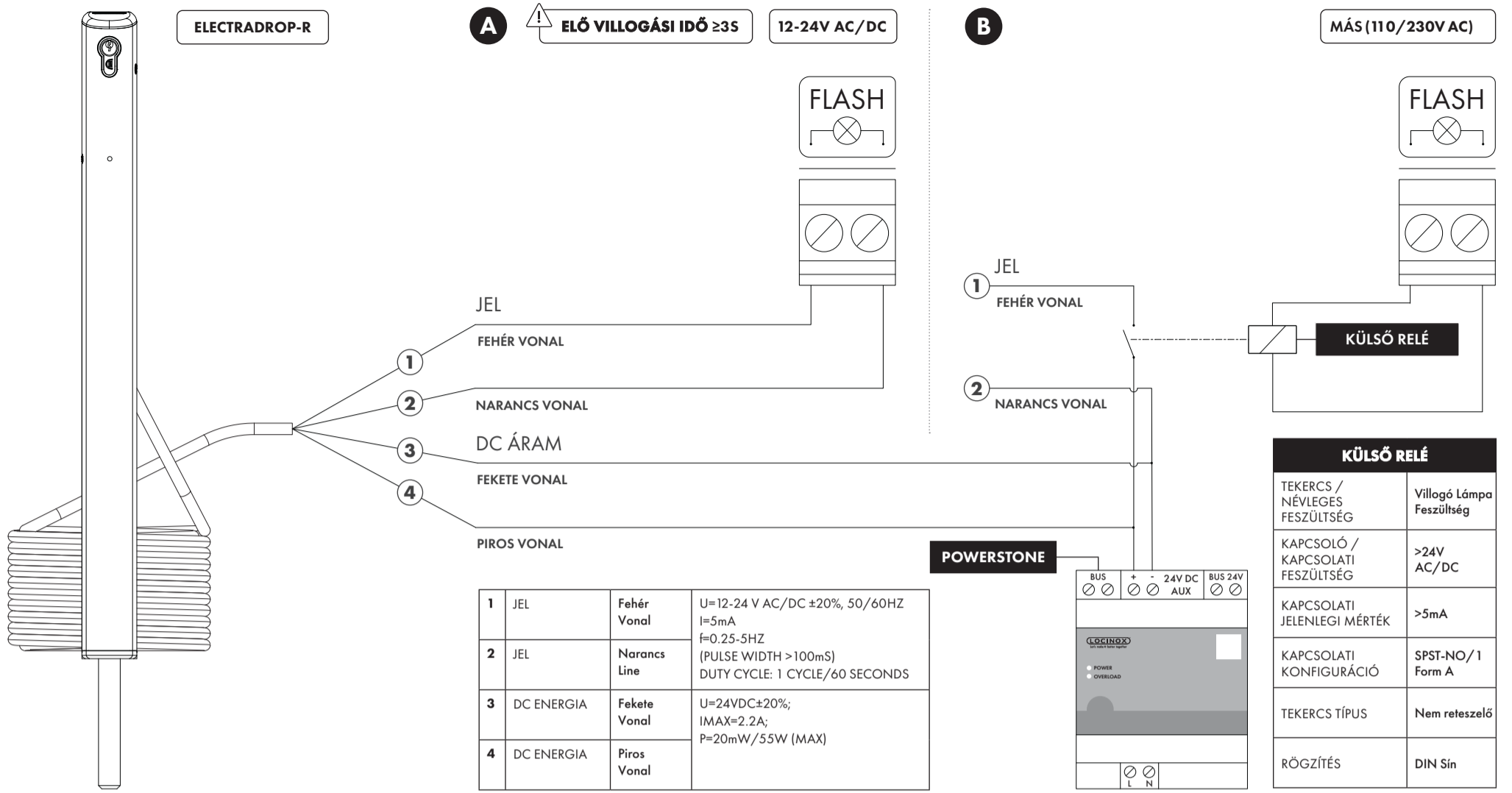

KIMENETI POZÍCIÓ

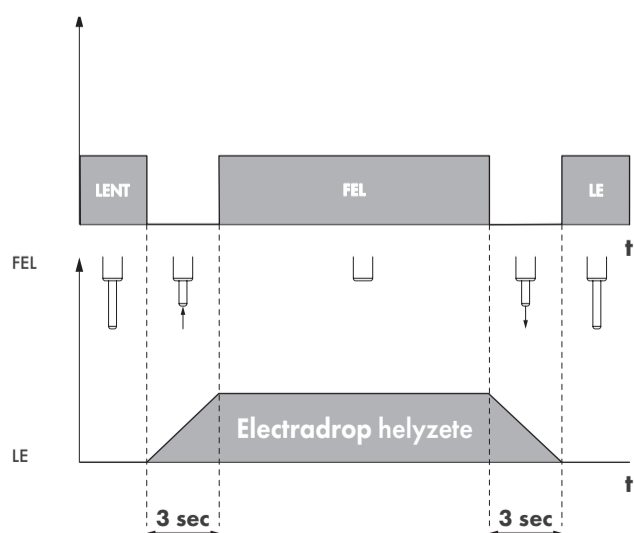

ELECTRADROP-R FOLYAMATOS JELZÉS

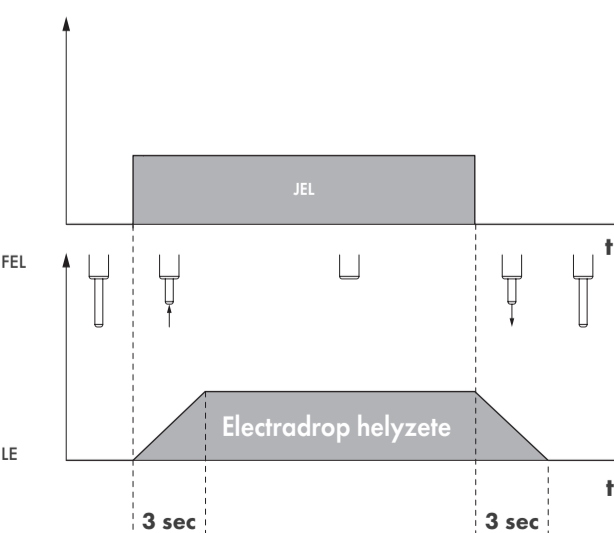

ELECTRADROP-R PULZÁLÓ JELZÉS

FREKVENCIA=0.25-5HZ
(PULS WIDTH >100mS)

